



These valves are among the smallest 2 or 3-way solenoid valves due to their compact size. Their body is made of thermoformed technopolymer. The interchangeable coil (U05) is fixed to the valve body with a spring clip and can be orientated in 90° increments. The response times can be considerably improved with the support of command electronics.

TECHNICAL CHARACTERISTICS

Valves made of a thermoplastic material, with internal parts in stainless steel and brass; seals are in nitrilic rubber. They can be mounted on single or multiple subbases.

Fluid: 10 μ filtered industrial air, lubricated or not lubricated
 Fluid temperature: 0° +55°C
 Ambient temperature: -5° +50°C
 Cycles per minute: 2700
Coil: interchangeable **U05** part number DD-... (Section Accessories page 11-V).
 Electrical connections: miniature connectors (Section Accessories pages 12-V).

2/2 - NC

3/2 - NC

2/2 - NO

3/2 - NO

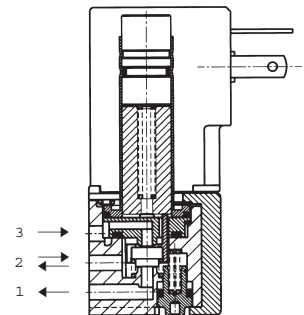
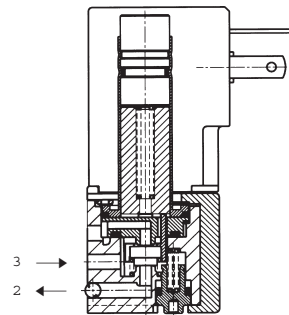
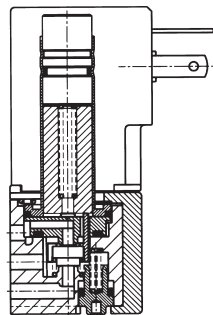
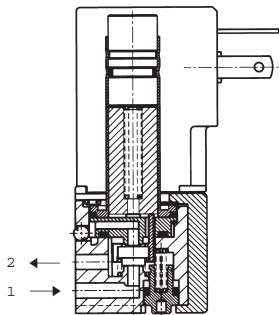

1 = Supply
 2 = Consumption
 3 = Exhaust

1 = Exhaust
 2 = Consumption
 3 = Supply

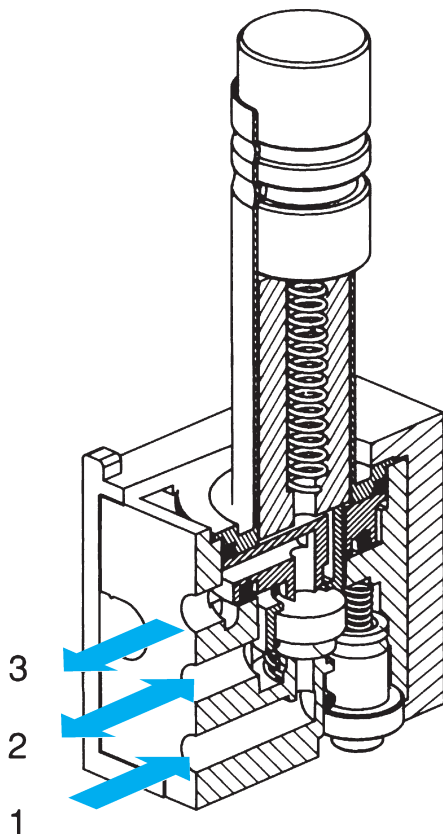



Overall dimensions

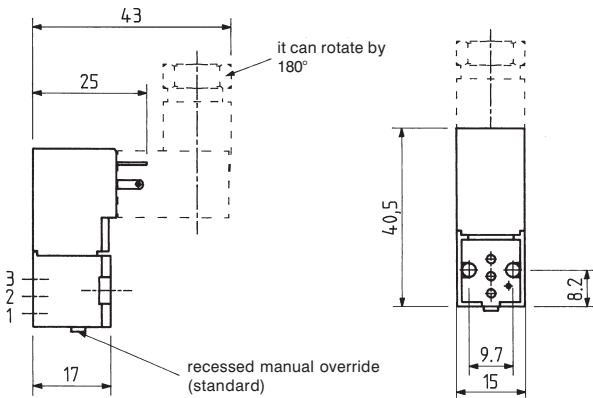

Manual override



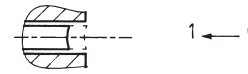

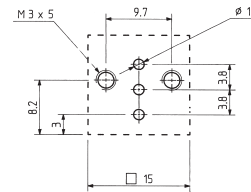

Microvalves are equipped with a standard recessed manual override that can only be operated with a drift.

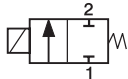
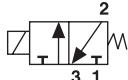

Drilling jig assemble the valve on a smooth surface with a sealing plate in between part no. **A - 299 - 11**.

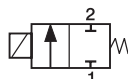
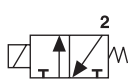

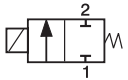
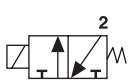

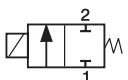
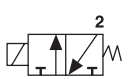

NOTE: an indicative estimate of the factor "CV" can be obtained by dividing the capacity values expressed in NI/min by "962"

Type	Symbol	Ways	Pressure bar	Nominal diameter	Capacity NI/min.	Power consumption ⚡	Time ms		Mass kg *	Part number
							Energ. (14)	De-energ. (12)		
 Direct current only		2/2 NC	0 ÷ 9	1,2	26	1,5W (2W-24 V c.c.)	11	11	0,018 (0,037)	A-141N
		3/2 NC								A-101N
 Direct current only		2/2 NC	0 ÷ 8	1,5	38	2,5W	11	11	0,018 (0,037)	A-142N
		3/2 NC								A-102N
 Direct and alternate current		2/2 NC	0 ÷ 9	1,2	26	1,5W 2,3 VA (2W-24 V c.c.)	11	11	0,018 (0,037)	A-151N
		3/2 NC								A-111N
 Direct and alternate current		2/2 NC	0 ÷ 8	1,5	38	2,5W 3,5 VA	11	11	0,018 (0,037)	A-152N
		3/2 NC								A-112N

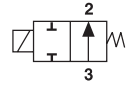
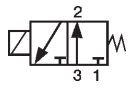

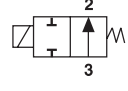
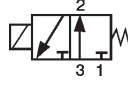

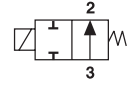
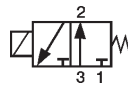

⚡ We suggest that the coils used have a minimum power consumption which corresponds to the indicated values. See "Accessories" for the various types of coils and electrical connectors.

* The mass between brackets refers to the coil with 1 piston.

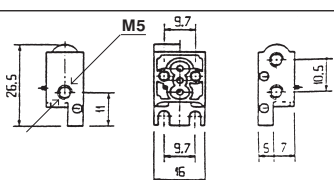
Type	Symbol	Ways	Pressure bar	Nominal diameter	Capacity NI/min.	Power consumption	Time ms		Mass kg *	Part number
							Energ.(14)	De-energ.(12)		
 Direct current only		2/2 NO	0 ÷ 9	1,2	26	1,5W (2W-24 V c.c.)	11	11	0,018 (0,037)	A-161N
		3/2 NO								A-121N
 Direct current only		2/2 NO	0 ÷ 9	1,5	38	2,5W	11	11	0,018 (0,037)	A-162N
		3/2 NO								A-122N
 Direct and alternate current		2/2 NO	0 ÷ 9	1,2	26	1,5W (2W-24 V c.c.) 2,3 VA	11	11	0,018 (0,037)	A-171N
		3/2 NO								A-131N

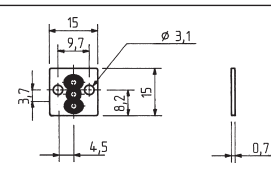
◆ We suggest that the coils used have a minimum power consumption which corresponds to the indicated values. See "Accessories" for the various types of coils and electrical connectors.

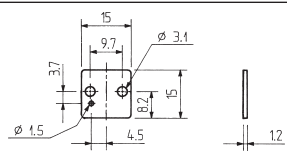
* The mass between brackets refers to the coil with Faston.

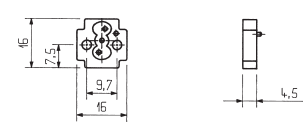
Type	Overall dimensions	Material	Connections	Mass kg	Part number
Single base					
		Zamak	M5	0,012	A-305
Sealing plate					
		Aluminium	-	0,003	A-299-11
It blocks the seal in place when the valve is mounted on a smooth surface without a seal housing.					
Blank plate					
		Aluminium	-	0,002	A-301
Unused valve stations must be closed with the blanking plate.					
Inverter					
		Plastic material	-	0,002	A-350

NO and NC valves can be mounted on a single blank inverting this device between the NO valve and the sub-base.
If all are NO valves, just invert air supply, without using the inverter.



Sub-base **without connector type "D"**.... in extruded anodized aluminium up to max. 32 stations with conveyed supplies and exhausts for assembling NC or NO valves.
 If NC and NO valves are assembled on one unique base, it is necessary to insert the inverter part n. A-350 for NO valves.

A - 326 A * threaded connections G 1/8 standard

* part number to be completed with the number of stations required

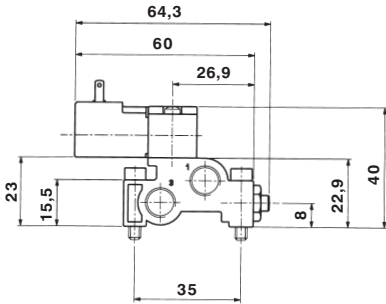

1 = Supply 3 = Exhaust **NC** Valves
 3 = Supply 1 = Exhaust **NO** Valves

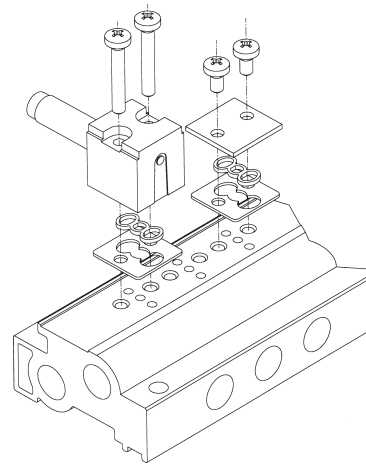
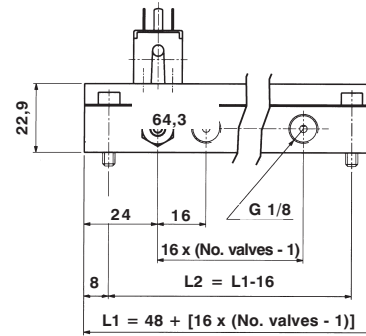
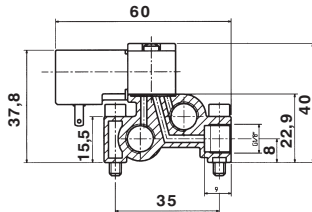

Sub-base **without connector type "D"**.... in extruded anodized aluminium up to max. 13 stations with connector 15 pin (upon request up to 23 with connector 25 pin) and threaded standard connections G 1/8, with conveyed supply and exhausts for assembling NC or NO valves with integrated coil connection and optical indication of the valve activation.

If both, NO and NC valves are assembled on one unique sub-base, NC valves are always mounted on the connector side and afterwards the NO valves and in the latter is inserted the inverter (part no. A-350) and the sealing plate (A-299-11).

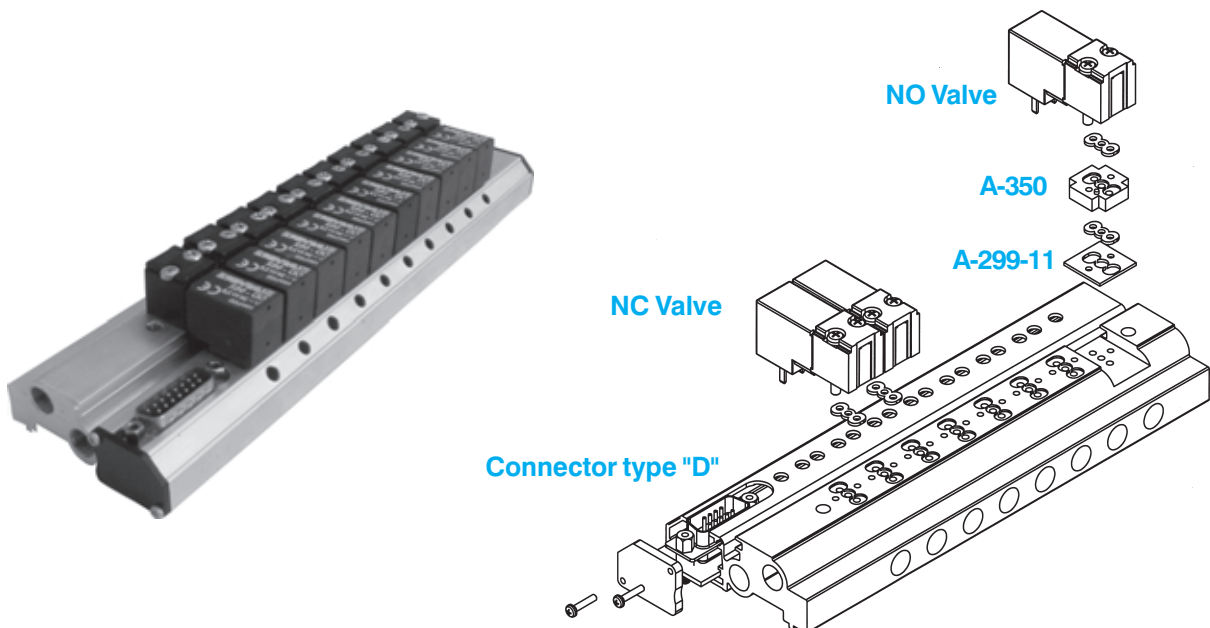

Valve blocks are produced according to drawing, please contact our Commercial Department.

www.57382299.com

Sub-base for valves all NC or all NO

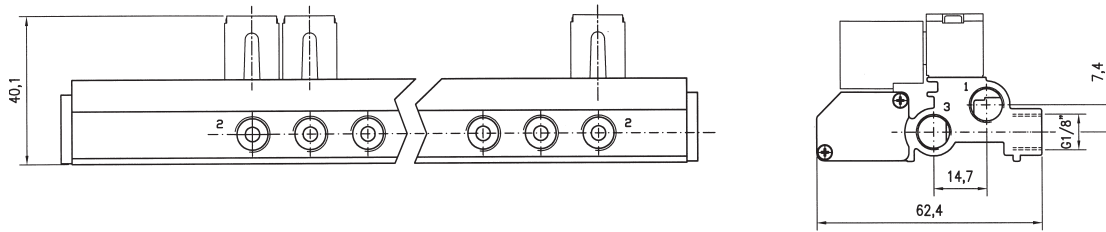

Sub-base for valves NC-NO

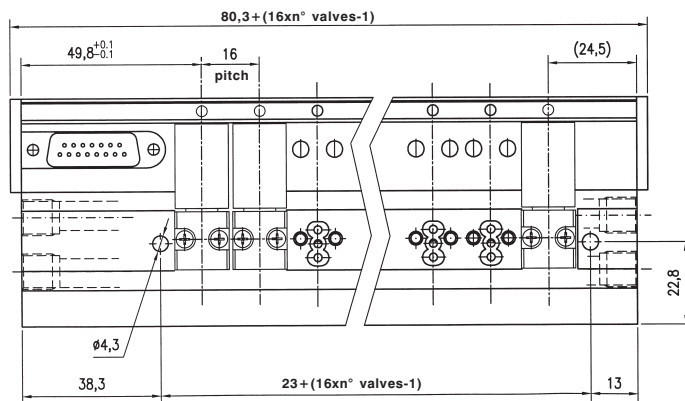
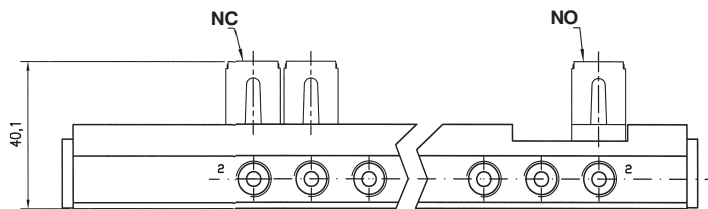

- 1 = Supply
- 3 = Exhaust NC Valves
- 3 = Supply
- 1 = Exhaust NO Valves

Wiring diagram PNP logic connection

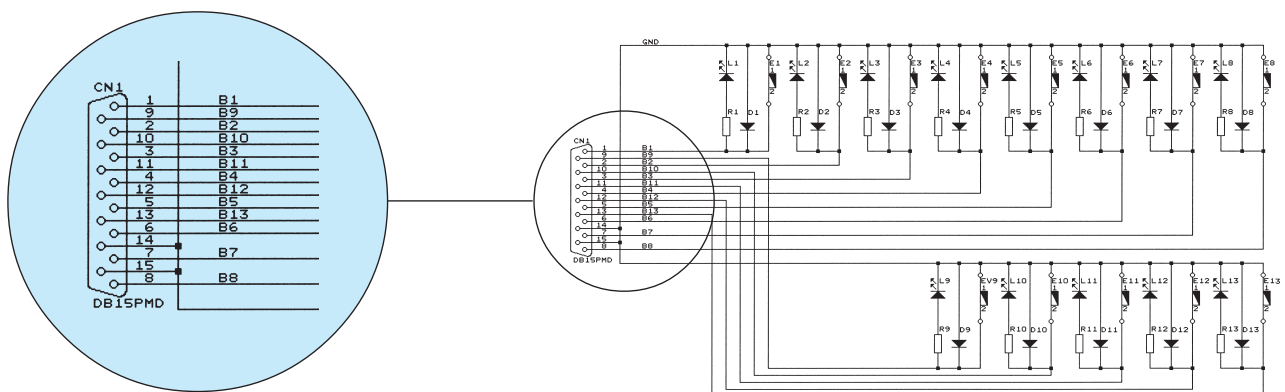

Female connector

Dimensions	Type	A	B	C	D	Mass kg	Part number		
							Without cable	Cable 1000 mm	Cable 2000 mm
	15 poles	33,3	42,3	37,3	14,5	0,032	D-600-15	D-601-15	D-602-15
	25 poles	47	55	37	14,5	0,037	D-600-25	D-601-25	D-602-25

Upon request 1 m cable extension with male and female connector, part no. 15 poles D-604-15, 25 poles D-654-25